

Vertical self-aligning Bearing With Seat

Reducing type, sn2c type, sn3c type-**SN305C**

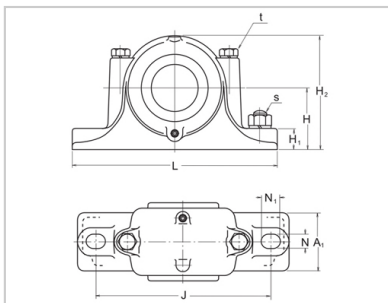
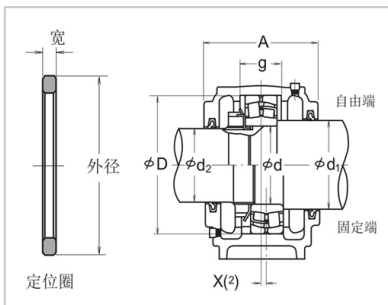

model :	SN305C
d :	52

Dimension (mm) :

d1 :	30
d2 :	20
D :	62
H :	50
J :	150
N :	15
N1 :	20
A :	80
L :	185
A1 :	52
H1 :	22
H2 :	90
g :	34
t :	M 8
s :	M 12

reference resources :	1.6
-----------------------	-----

Applicable parts :

Self aligning ball bearing :	2305
Rated dynamic load Cr (n) :	24900
Spherical Roller Bearings :	—
Rated dynamic load Cr (n) :	—
Nut :	AN05
Washer :	AW 05 ×

Locating ring : SR 62 × 10

number : 1

oil seal :

D1 end : GS 7

D2 end : GS 5

: