

Vertical self-aligning Bearing With Seat

Reducing type, sn2c type, sn3c type-**SN307C**

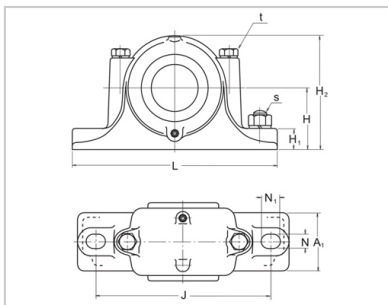
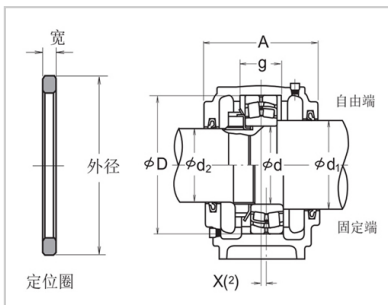

model :	SN307C
d :	35

Dimension (mm) :

d1 :	45
d2 :	30
D :	80
H :	60
J :	170
N :	15
N1 :	20
A :	90
L :	205
A1 :	60
H1 :	25
H2 :	110
g :	41
t :	M 10
s :	M 12

reference resources :	2.6
-----------------------	-----

Applicable parts :

Self aligning ball bearing :	2307
Rated dynamic load Cr (n) :	40000
Spherical Roller Bearings :	—
Rated dynamic load Cr (n) :	—
Nut :	AN07
Washer :	AW 07 ×

Locating ring : SR 80 × 10

number : 1

oil seal :

D1 end : GS 10

D2 end : GS 7

: