

Vertical self-aligning Bearing With Seat

Reducing type, sn2c type, sn3c type-**SN207C**

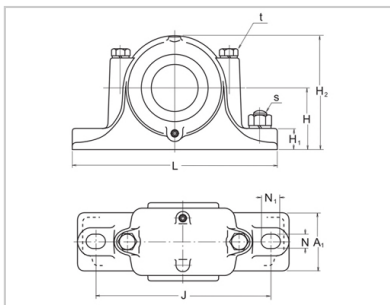
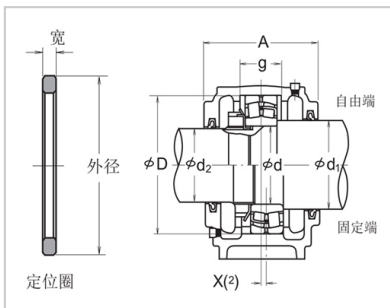

model :	SN207C
d :	35

Dimension (mm) :

d1 :	45
d2 :	30
D :	72
H :	50
J :	150
N :	15
N1 :	20
A :	82
L :	185
A1 :	52
H1 :	22
H2 :	95
g :	33
t :	M 10
s :	M 12

reference resources :	1.9
-----------------------	-----

Applicable parts :

Self aligning ball bearing :	2207
Rated dynamic load Cr (n) :	21700
Spherical Roller Bearings :	22207H
Rated dynamic load Cr (n) :	78500
Nut :	AN07
Washer :	AW 07 ×

Locating ring : SR 72 × 10

number : 1

oil seal :

D1 end : GS 10

D2 end : GS 7

: