

Vertical self-aligning Bearing With Seat

Reducing type, sn2c type, sn3c type-**SN205C**

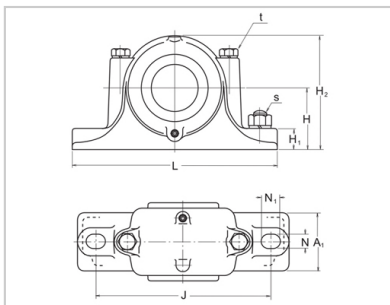
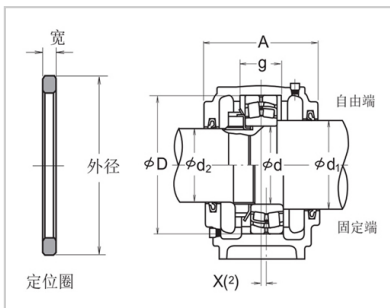

model :	SN205C
d :	25

Dimension (mm) :

d1 :	30
d2 :	20
D :	52
H :	40
J :	130
N :	15
N1 :	20
A :	67
L :	165
A1 :	46
H1 :	22
H2 :	75
g :	25
t :	M 8
s :	M 12

reference resources :	1.1
-----------------------	-----

Applicable parts :

Self aligning ball bearing :	1205
Rated dynamic load Cr (n) :	12200
Spherical Roller Bearings :	—
Rated dynamic load Cr (n) :	—
Nut :	AN05
Washer :	AW 05 ×

Locating ring : SR 52 × 5

number : 2

oil seal :

D1 end : GS 7

D2 end : GS 5

: